

ELEGANTE SYSTEM LED CONNECTOR X 580X580MM

1400LM OPAL IP40 840 (16W)

DETAILED CARD

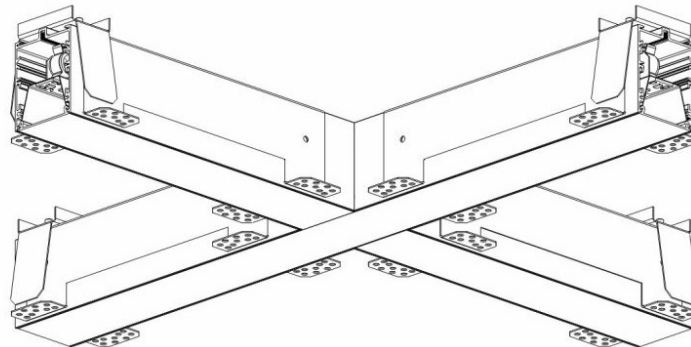

TECHNICAL PARAMETERS

Index:	388019
Ingress protection:	IP40/20
Impact resistance:	IK04
Nominal power [W]:	16
Luminous flux [lm]*:	1400
Colour temperature [K]:	4000
SDCM:	≤ 3
Energy efficiency class:	F
Material of the body:	aluminium
Colour of the body:	silver

CHARACTERISTICS

ELEGANTE LED SYSTEM is a modern office fixture designed for flush mounting. It provides a combination of high light parameters and a modern decorative effect. The optical design has been designed using an iridescent diaphragm with high permeability and uniform light distribution. Available system switches allow for the design of concealed light lines in various configurations (T, X, L). The advantage of the system's roofs is the lampshade without connections to max. length 25m.

There is also a version of individual fittings.

Available 2 power options - to connect as part of:

- 16W i 8W,
- 30W i 15W.

Assembly should be carried out by qualified person.

Please feel free to contact our lighting designers.

APPLICATION

The luminaire is dedicated for internal use. For use in office and commercial facilities, in particular in representative rooms.

ELEGANTE SYSTEM LED CONNECTOR X 580X580MM

1400LM OPAL IP40 840 (16W)

DETAILED CARD

TECHNICAL PARAMETERS TABLE

Nominal power [W]:	16	Colour of the body:	silver
Light source:	LED module	Mounting dimensions [mm]:	580/55/580/55
Colour temperature [K]:	4000	Impact resistance:	IK04
Luminous flux [lm]:	1400	Mounting version:	recessed
Rated power of the luminaire [W]:	17.68	Working temperature [°C]:	from -20 to +35
Diffuser type:	OPAL	Accessories included:	diffuser
Supply voltage [V]:	220-240	Through wiring:	3x2.5
Frequency [Hz]:	50 - 60	Net weight [kg]:	2.300
Version:	X connector	Gross weight [kg]:	2.800
Source luminous flux [lm]*:	2446	Index:	388019
Dimensions (H/W/T/S) [mm]:	580/580/65	EAN:	5905963388019
Ingress protection:	IP40/20	Category type:	systems
Luminous efficacy [lm/W]:	79	Product line:	SYSTEM 16W/8W
Energy efficiency class:	F	LED lifespan L80B20 [h]:	73000
Electrical protection class:	I	LED lifespan L90B10 [h]:	36000
Colour rendering index:	>80	Light distribution type:	open space
SDCM:	≤ 3	Kolejność:	D
Power factor:	0.86	ETIM class:	EC000282
LED lifespan L70B50 [h]:	115000	CE certificate:	244/2023
Diffuser material:	PC	Photobiological safety:	Risk Group 1 (no photobiological hazard under normal behavioral limitation)
Diffuser colour:	white	Warranty [years]:	5
Material of the body:	aluminium	Manual:	Download PDF
		Plik LDT:	Download

ELEGANTE SYSTEM LED CONNECTOR X 580X580MM 1400LM OPAL IP40 840 (16W)

DETAILED CARD

ACCESSORIES AVAILABLE

index	Name
81000945	ELEGANTE LED SYSTEM - OPAL diffuser - 1 rm (max 25 rm)
388736	ELEGANTE SYSTEM LED end set
388743	ELEGANTE SYSTEM LED gniazdo 3 polowe
388750	ELEGANTE SYSTEM LED gniazdo 5 polowe
388767	ELEGANTE SYSTEM LED wtyk 3 polowy
388774	ELEGANTE SYSTEM LED wtyk 5 polowy
388729	ELEGANTE SYSTEM LED klosz PC opal co-extrusion+soft fixing part 25m



ELEGANTE SYSTEM LED gniazdo 3 polowe (388743)



ELEGANTE SYSTEM LED gniazdo 5 polowe (388750)



ELEGANTE SYSTEM LED wtyk 3 polowy (388767)



ELEGANTE SYSTEM LED wtyk 5 polowy (388774)



ELEGANTE SYSTEM LED klosz PC opal co-extrusion+soft fixing part 25m (388729)

Card creation date: 03 January 2025

The company reserves the right to make design changes or upgrades in the presented product. Product data sheet does not constitute an offer. * Parameter tolerance is +/- 10%



This product is a subject to electric and electronic waste equipment regulations (WEEE).



Certificate CE - Nr: 244/2023