

LUMEDIC 595X595MM SW 7050LM RA95 3000K GLASS/PRM LNS IP65 I CL. DALI W IK09 R 83W

DETAILED CARD



TECHNICAL PARAMETERS

Index:	789755
Ingress protection:	IP65
Impact resistance:	IK09
Rated power of the luminaire [W]*:	83
Luminous flux [lm]*:	7050
Colour temperature [K]:	3000
Color rendering index (Ra) >:	95
Energy efficiency class:	F
Material of the body:	powder coated steel
Diffuser material:	szyba hartowana

CHARACTERISTICS

Lumedic SW R CRI95 is a specialist Cleanroom luminaire designed for clean rooms with increased hygiene and sterility requirements. Its design ensures ease of cleaning and high mechanical and environmental resistance. A robust steel housing with IP65 protection on the room side and IP50 on the technical side ensures complete tightness in a sterile environment, while allowing free air flow above the suspended ceiling. Service access is provided from the technical side (top inspection), allowing maintenance without interfering with the clean room.

The luminaire is characterised by very high colour rendering quality (CRI > 95), with high values for the R9 = 94.7 and R13 = 98.9 components. The R9 parameter, responsible for the reproduction of saturated red colours, is crucial in medical diagnostics, surgery and laboratory analyses, where precise differentiation of shades of blood, tissues and biological materials is critical. A high R9 value indicates the use of light sources with a full, continuous spectrum, which is not available for standard LED luminaires.

The R13 parameter refers to the faithful reproduction of skin tones and materials with light, pastel shades. An R13 value of 98.9 ensures a natural appearance of work surfaces, hands and staff faces, reducing eye strain and the risk of visual misjudgement in high-responsibility environments such as operating theatres, pharmaceutical laboratories and quality control rooms.

The front of the luminaire is made of aluminium and 4 mm thick tempered glass, resistant to impact (IK09 class) and chemicals. The modular shutter system (Glass / Opal / PRM) allows you to select the appropriate optical characteristics depending on the application requirements — from uniform, diffused light to precise directional distribution. The SW R version is designed for installation in reinforced ceilings.

APPLICATION

- laboratories (microbiological, pharmaceutical, chemical),
- hospitals (operating theatres, intensive care units, diagnostic laboratories),
- food and pharmaceutical industry,
- cleanrooms in electronics and semiconductor manufacturing.

LUMEDIC 595X595MM SW 7050LM RA95 3000K GLASS/PRM LNS IP65 I CL. DALI W IK09 R 83W

DETAILED CARD

TECHNICAL PARAMETERS TABLE

Index:	789755	Ring colour:	biały Ral 9003
EAN:	5905963789755	Dimensions (H/W/T/S) [mm]:	595/595/65
Light source:	LED module	Mounting dimensions [mm]:	585/585
Rated power of the luminaire [W]:	83	Impact resistance:	IK09
Supply voltage [V]:	220 - 240	Ingress protection:	IP65
Frequency [Hz]:	0/50/60	Mounting version:	recessed
Luminous flux [lm]:	7050	Working temperature [°C]:	from -20 to +35
Luminous efficacy [lm/W]:	85	LED lifespan L70B50 [h]:	200000
Energy efficiency class:	F	LED lifespan L80B10 [h]:	100000
Electrical protection class:	I	LED lifespan L90B10 [h]:	50000
Colour temperature [K]:	3000	DIMM DALI:	yes
Color rendering index (Ra) >:	95	Number on the palette [pcs]:	16
Power factor:	0.97	Net weight [kg]:	11
Diffuser material:	szyba hartowana	Photobiological safety:	RG0 - exempt (no photobiological hazard)
Diffuser type:	Glass/PRM	Warranty [years]:	5
Optics material:	PS	CE certificate:	36/2026
Optics:	PRM	Environmental Product Declaration (EPD):	869/2025
Material of the body:	powder coated steel	Manual:	Download PDF
Colour of the body:	biały Ral 9003	ISO Certificates:	9001:2015, 14001:2015, 45001:2018, 50001:2018
Ring material:	aluminium	Plik LDT:	Download

LUMEDIC 595X595MM SW 7050LM RA95 3000K GLASS/PRM LNS IP65 I CL. DALI W IK09 R 83W

DETAILED CARD

TECHNICAL PICTURES

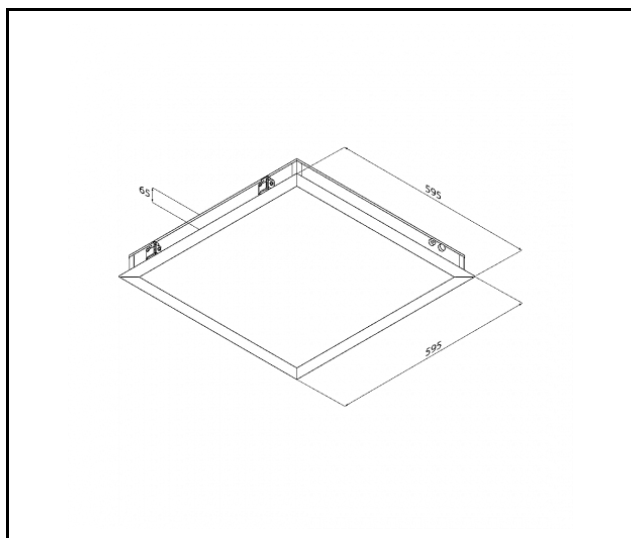

Card creation date: 24 March 2026

The company reserves the right to make design changes or upgrades in the presented product. Product data sheet does not constitute an offer. * Parameter tolerance is +/- 10%



This product is a subject to electric and electronic waste equipment regulations (WEEE).



Certificate CE - Nr: 36/2026