

LUNGO II TRACK 1950LM 40° II CL. IP20 BLACK 940 (18W)

DETAILED CARD



TECHNICAL PARAMETERS

Index:	703430
Rated power of the luminaire [W]*:	18
Luminous flux [lm]*:	1950
Colour temperature [K]:	4000
Color rendering index (Ra) >:	90
Beam angle [°]:	40
Material of the body:	aluminium
Colour of the body:	black
Ring colour:	black
Dimensions (H/W/T/S) [mm]:	fi=60 L=170

CHARACTERISTICS

The Lungo II LED Track luminaire is equipped with an integrated, durable and energy-efficient LED module that provides a luminous flux of up to 1330 lm, depending on the selected version. The user can choose one of three colour temperatures: 2700 K, 3000 K or 4000 K, as well as two colour rendering index variants – Ra 80 or Ra 90, which allows the light quality to be adjusted to the nature of the space. The luminaire offers three light distribution angles: 20°, 40° and 70°, making it suitable for both accent and general lighting. The body is made of a powder-coated aluminium housing, available in white, black, grey or black with a gold interior. The IP20 protection rating allows the luminaire to be used indoors, while the track version is fully compatible with 3-phase busbar systems, ensuring flexibility in installation and lighting configuration.

APPLICATION

Luminaire is used in spaces such as:

- corridors and passageways in office and institutional buildings
- entrance areas and lobbies
- staircases
- reception areas

LUNGO II TRACK 1950LM 40° II CL. IP20 BLACK 940 (18W)

DETAILED CARD

TECHNICAL PARAMETERS TABLE

Index:	703430	Optics material:	aluminium
EAN:	5905963703430	Material of the body:	aluminium
Category type:	decorative fixtures	Colour of the body:	black
Category of application:	architectural, office lighting, commercial facilities	Ring material:	aluminium
Light source:	COB	Ring colour:	black
Rated power of the luminaire [W]:	18	Dimensions (H/W/T/S) [mm]:	fi=60 L=170
Luminous flux [lm]:	1950	Mounting dimensions [mm]:	L= 40mm fi6mm
Supply voltage [V]:	220-240	Ingress protection:	IP20
Frequency [Hz]:	0/50/60	Mounting version:	track
Luminous efficacy [lm/W]:	108	Dimensions of single box [mm]:	260/130/65
Energy efficiency class:	E	Number on the palette [pcs]:	480
Electrical protection class:	II	Net weight [kg]:	0.515
Colour temperature [K]:	4000	Gross weight [kg]:	0.585
Color rendering index (Ra) >:	90	Photobiological safety:	Risk Group 1 (no photobiological hazard under normal behavioral limitation)
LED lifespan L90B10 [h]:	50000	Warranty [years]:	5
Beam angle [°]:	40	CE certificate:	01/2026
Exchangeable source:	yes	Manual:	Download PDF
Optics:	reflector	Plik LDT:	Download

LUNGO II TRACK 1950LM 40° II CL. IP20 BLACK 940 (18W)

DETAILED CARD

TECHNICAL PICTURES

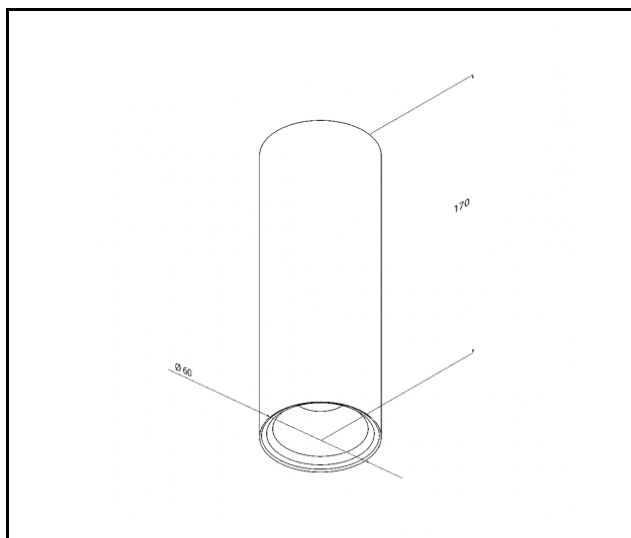

Card creation date: 05 January 2026

The company reserves the right to make design changes or upgrades in the presented product. Product data sheet does not constitute an offer. * Parameter tolerance is +/- 10%



This product is a subject to electric and electronic waste equipment regulations (WEEE).



Certificate CE - Nr: 01/2026