

QUEST LED EVO XS ENDURA 5550LM I CL. IP67 740 20D 35W

DETAILED CARD



TECHNICAL PARAMETERS

Index:	791178
Ingress protection:	IP67
Impact resistance:	IK10
Rated power of the luminaire [W]*:	34
Luminous flux [lm]*:	5550
Colour temperature [K]:	4000
Color rendering index (Ra) >:	70
SDCM:	3
Electrical protection class:	I
Energy efficiency class:	B

CHARACTERISTICS

The Endura version of Quest LED Evo XS luminaires, their high-bay versions: surface-mounted Quest LED Evo XS HB NT and suspended Quest LED Evo XS HB Z are compact yet extremely efficient premium floodlights, manufactured in Poland, adapted to operate at high temperatures (up to 50 degrees C). The body is made of die-cast aluminium in corrosion class C5, powder coated, without an external heat sink and fins that make it difficult to keep clean. The basic version has a steel arm with a 7.5-degree scale, while the highbay endura (HB NT) version is available in a surface-mounted form. The diffuser is made of tempered glass, under which there are LEDs with the highest efficiency. Different types of optics, especially asymmetrical ones, provide great freedom in choosing the right solution for a specific application. Thanks to the highest tightness rating on the market (IP67) and maximum impact resistance (IK10), it will perform well in all conditions, regardless of the weather and installation location. The new version of the renowned and proven QUEST model in its smallest version offers even better lighting parameters, achieving an efficiency of over 170 lm/W. The Endura variant also meets the requirements of PN-EN 60598-2 part 5, which allows them to be classified as illumination projectors. This means complete freedom of installation in any position, with 360° rotation and resistance to strong winds – an advantage not offered by other floodlights. An additional advantage for contractors is the sealed quick connector – an innovative solution that eliminates traditional, time-consuming connection methods (screws). Thanks to an intuitive system of coloured latches, connector installation is simple, quick and tool-free. The accessory kit includes: pole mounting brackets (basic version); frame for flush mounting, e.g. in shelters (basic version); light pollution reduction screens (basic version); protective grids in two colours with different degrees of light reduction (white RAL7016: 4%, body colour RAL7016: 8%).

APPLICATION

Quest LED Evo XS Endura and Quest LED Evo XS Endura HB NT are used in: lighting educational, administrative and institutional facilities, halls, garages, passageways, warehouses, shops, the food industry and commercial and service facilities related to food products. Illumination of buildings, small sports fields, open spaces and car parks, environments with elevated ambient temperatures (up to 50 degrees C). Installation options: as a floodlight, on poles and masts, on building facades, as a surface-mounted highbay (HB NT version), suspended highbay (HB Z version), flush-mounted (e.g. shelters). The product is particularly well suited for use in factories and production halls as well as large-area warehouses, especially in areas exposed to high temperatures.

QUEST LED EVO XS ENDURA 5550LM I CL. IP67 740 20D 35W

DETAILED CARD

TECHNICAL PARAMETERS TABLE

Index:	791178	Mounting dimensions [mm]:	100
EAN:	5905963791178	Impact resistance:	IK10
Light source:	LED	Ingress protection:	IP67
Rated power of the luminaire [W]:	34	Mounting version:	surface
Supply voltage [V]:	220-240	Working temperature [°C]:	from -20 to +50
Frequency [Hz]:	50/60	Number on the palette [pcs]:	81
Luminous flux [lm]:	5550	Net weight [kg]:	2.900
Luminous efficacy [lm/W]:	163	Category type:	floodlights
Energy efficiency class:	B	AC voltage range [V]:	100-305
Electrical protection class:	I	Version:	floodlight
Colour temperature [K]:	4000	LED lifespan L70B50 [h]:	165000
Color rendering index (Ra) >:	70	LED lifespan L80B10 [h]:	103000
SDCM:	3	LED lifespan L90B10 [h]:	48000
Beam angle [°]:	20	Corrosivity category:	C5-M
Surge protection [kV]:	6	Category of application:	industrial
Diffuser material:	glass	Warranty [years]:	5
Diffuser type:	transparent	CE certificate:	02/2025
Material of the body:	aluminium	Environmental Product Declaration (EPD):	816/2025
Colour of the body:	RAL7016	Manual:	Download PDF
Dimensions (H/W/T/S) [mm]:	280/240/55 (355/222/380)	Pliik LDT:	Download

QUEST LED EVO XS ENDURA 5550LM I CL. IP67 740 20D 35W

DETAILED CARD
TECHNICAL PICTURES

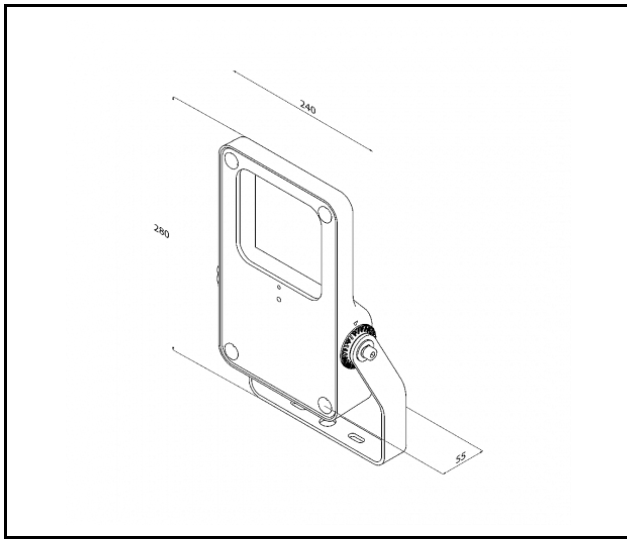

QUEST LED EVO XS ENDURA 5550LM I CL. IP67 740 20D 35W

DETAILED CARD

ACCESSORIES AVAILABLE

index	Name
WSEL438	Remote control for motion sensor HD01R
840456	QUEST LED EVO XS recessed frame RAL7016



Remote control for motion sensor
HD01R (WSEL438)



QUEST LED EVO XS recessed frame
RAL7016 (840456)

Card creation date: 12 September 2025

The company reserves the right to make design changes or upgrades in the presented product. Product data sheet does not constitute an offer. * Parameter tolerance is +/- 10%



This product is a subject to electric and electronic waste equipment regulations (WEEE).



Certificate CE - Nr. 02/2025