

QUEST LED EVO XS 6550LM DALI I CL. IP67 740 45D 41W

DETAILED CARD



TECHNICAL PARAMETERS

Index:	791475
Ingress protection:	IP67
Impact resistance:	IK10
Rated power of the luminaire [W]*:	40
Luminous flux [lm]*:	6550
Colour temperature [K]:	4000
Color rendering index (Ra) >:	70
SDCM:	3
Electrical protection class:	I
Energy efficiency class:	B

CHARACTERISTICS

Quest LED Evo XS, their high-bay versions: surface-mounted Quest LED Evo XS HB NT and suspended Quest LED Evo XS HB Z are compact yet extremely efficient premium class floodlights manufactured in Poland. Their body is made of die-cast aluminium, powder coated, without an external heat sink and fins that make cleaning difficult. The luminaire is designed for use in highly corrosive, marine C5-M environments. The diffuser is made of tempered glass, under which there are high-performance LEDs. Various types of optics, especially asymmetrical ones, provide great freedom in selecting the right solution for a specific application. Thanks to the highest tightness on the market (IP67) and maximum impact resistance (IK10), the floodlights will work in all conditions – regardless of the weather and installation location. The new version of the recognised and proven QUEST model offers even better lighting parameters, achieving an efficiency of over 170 lm/W. Quest LED Evo XS meets the requirements of PN-EN 60598-2 part 5, which allows it to be classified as an illumination projector, enabling complete freedom of installation in any position, with 360° rotation and resistance to strong winds. An additional advantage for contractors is the sealed quick connector – an innovative solution that eliminates traditional, time-consuming connection methods. Thanks to an intuitive system of coloured latches, connector installation is simple, quick and tool-free. The HB NT version is designed for surface mounting as a highbay using dedicated brackets. The HB Z version is designed for suspension. The accessory kit includes brackets for pole mounting, a frame for flush mounting (e.g. shelters), light pollution reduction screens and protective grids in two colours with different degrees of light reduction (white RAL7016: 4%, body colour RAL7016: 8%). The models are also available with a built-in motion and twilight sensor (RCR remote control) and in the ENDURA version, resistant to elevated ambient temperatures up to 50°C. In addition, a version designed for RGB+W illumination and for surface-mounted and suspended installation as a highbay is available.

APPLICATION

Quest LED Evo XS floodlights and their surface-mounted versions, Quest LED Evo XS HB NT, are widely used in lighting educational, administrative and recreational facilities, halls, garages, passageways, warehouses, shops, as well as in the food industry and commercial and service facilities related to food products. They are the ideal solution for illuminating buildings, small sports fields, open spaces and car parks. They can be mounted as floodlights on poles and masts, on building facades, as well as surface-mounted highbays (HB NT version) and suspended highbays (HB Z version). Thanks to the flush-mounted option, they are perfect for shelters. Quest LED Evo XS is an excellent choice for factories, production halls and large warehouses.

QUEST LED EVO XS 6550LM DALI I CL. IP67 740 45D 41W

DETAILED CARD

TECHNICAL PARAMETERS TABLE

Index:	791475	Impact resistance:	IK10
EAN:	5905963791475	Ingress protection:	IP67
Light source:	LED	Mounting version:	surface
Rated power of the luminaire [W]:	40	Working temperature [°C]:	from -20 to +50
Supply voltage [V]:	220-240	DIMM DALI:	yes
Frequency [Hz]:	50/60	Number on the palette [pcs]:	81
Luminous flux [lm]:	6550	Net weight [kg]:	2.900
Luminous efficacy [lm/W]:	164	Category type:	floodlights
Energy efficiency class:	B	LED lifespan L70B50 [h]:	165000
Electrical protection class:	I	LED lifespan L80B10 [h]:	103000
Colour temperature [K]:	4000	LED lifespan L90B10 [h]:	48000
Color rendering index (Ra) >:	70	Version:	floodlight
SDCM:	3	Corrosivity category:	C5-M
Beam angle [°]:	45	Category of application:	industrial
Surge protection [kV]:	6	Warranty [years]:	5
Diffuser material:	glass	CE certificate:	02/2025
Diffuser type:	transparent	Environmental Product Declaration (EPD):	816/2025
Material of the body:	aluminium	Manual:	Download PDF
Colour of the body:	RAL7016	ISO Certificates:	9001:2015, 14001:2015, 45001:2018, 50001:2018
Dimensions (H/W/T/S) [mm]:	280/240/55 (355/222/380)**	Plik LDT:	Download
Mounting dimensions [mm]:	100		

QUEST LED EVO XS 6550LM DALI I CL. IP67 740 45D 41W

DETAILED CARD

TECHNICAL PICTURES

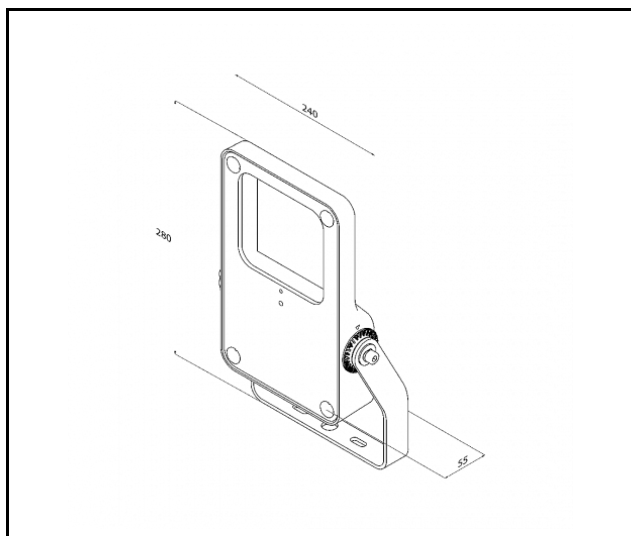

QUEST LED EVO XS 6550LM DALI I CL. IP67 740 45D 41W

DETAILED CARD

ACCESSORIES AVAILABLE

index	Name
840395	QUEST LED EVO XS pole holder
840425	QUEST LED EVO XS protective grid RAL7016
840456	QUEST LED EVO XS recessed frame RAL7016
840487	QUEST LED EVO XS cover RAL7016
881732	QUEST LED EVO XS protective grid RAL9003
WSE0005	RC MOS MR004 IoT programming remote control

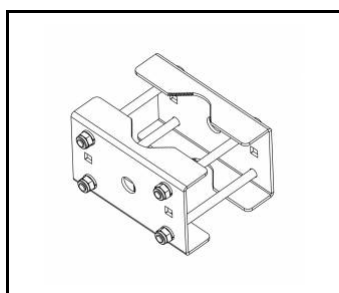

QUEST LED EVO XS pole holder (840395)

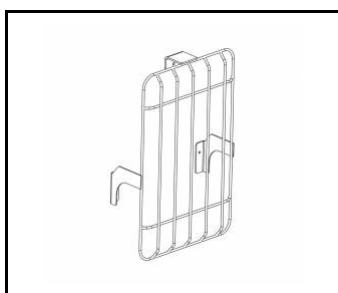

QUEST LED EVO XS protective grid RAL7016 (840425)

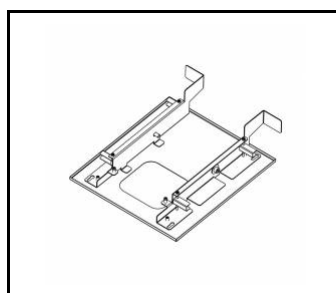

QUEST LED EVO XS recessed frame RAL7016 (840456)

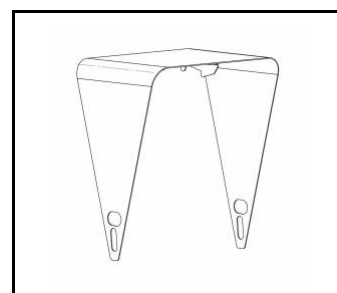

QUEST LED EVO XS cover RAL7016 (840487)

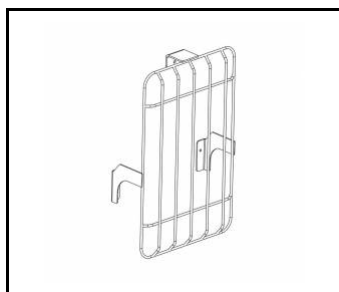

QUEST LED EVO XS protective grid RAL9003 (881732)

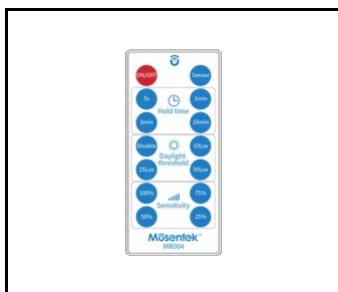

RC MOS MR004 IoT programming remote control (WSE0005)

Card creation date: 25 June 2026

The company reserves the right to make design changes or upgrades in the presented product. Product data sheet does not constitute an offer. * Parameter tolerance is +/- 10%

 This product is a subject to electric and electronic waste equipment regulations (WEEE).

 Certificate CE - Nr: 02/2025