

QUEST LED EVO EVEREST 24300LM I CL. IP66 840 MW (85D) 150W

DETAILED CARD



TECHNICAL PARAMETERS

Index:	792014
Ingress protection:	IP66
Impact resistance:	IK10
Rated power of the luminaire [W]*:	150
Luminous flux [lm]*:	24300
Colour temperature [K]:	4000
Color rendering index (Ra) >:	80
SDCM:	3
Electrical protection class:	I
Energy efficiency class:	B

CHARACTERISTICS

The Quest LED Evo Everest is the pinnacle of technology in the field of high-bay luminaires. The latest, largest and most powerful member of the renowned and proven QUEST family, designed for the most demanding production, logistics and warehouse spaces. It combines exceptional light efficiency, uncompromising durability and an aesthetic, industrial design. It is a modern, premium-class industrial luminaire, manufactured in Poland, designed for use in demanding environments thanks to its die-cast aluminium body, without an external heat sink and fins that make it difficult to keep clean, while perfectly dissipating excess heat. The diffuser is made of tempered glass, under which are high-performance LEDs. Various types of optics, especially asymmetrical ones, provide great freedom in selecting the right solution for a specific application. Thanks to the highest tightness rating on the market (IP66) and maximum impact resistance (IK10), EVEREST will perform well in all conditions – regardless of the weather and installation location, with an efficiency of 170 lm/W. An additional advantage for contractors is the sealed quick connector – an innovative solution that eliminates traditional, time-consuming connection methods. Thanks to an intuitive system of coloured latches, connecting the lamp is simple, quick and tool-free. A set of accessories allows you to expand the lamp with an additional module or modules, significantly increasing its lighting capabilities, which is particularly important for high halls. Models available with Zhaga D4i module.

APPLICATION

Quest LED Evo Everest is widely used in lighting educational, administrative and institutional facilities, halls, garages, passageways, warehouses, shops, as well as in the food industry and commercial and service facilities related to food products. They can be used as a solution for sports fields, open spaces and car parks.

QUEST LED EVO EVEREST 24300LM I CL. IP66 840 MW (85D) 150W

DETAILED CARD

TECHNICAL PARAMETERS TABLE

Index:	792014	Optics material:	PC
EAN:	5905963792014	Optics:	lens
Light source:	LED	Material of the body:	aluminium
Rated power of the luminaire [W]:	150	Colour of the body:	RAL7016
Luminous flux [lm]:	24300	Dimensions (H/W/T/S) [mm]:	570/441/87
Supply voltage [V]:	220-240	Mounting dimensions [mm]:	542/366
Frequency [Hz]:	50-60	Impact resistance:	IK10
Luminous efficacy [lm/W]:	162	Ingress protection:	IP66
Energy efficiency class:	B	Mounting version:	suspended
Electrical protection class:	I	Working temperature [°C]:	from -20 to +35
Colour temperature [K]:	4000	Dimensions of single box [mm]:	572
Color rendering index (Ra) >:	80	Number on the palette [pcs]:	42
SDCM:	3	Net weight [kg]:	9.200
LED lifespan L70B50 [h]:	161000	Warranty [years]:	5
LED lifespan L80B10 [h]:	100500	CE certificate:	98/2025
LED lifespan L90B10 [h]:	47500	Environmental Product Declaration (EPD):	816/2025
Beam angle [°]:	85	Manual:	Download PDF
Diffuser material:	glass	Surge protection [kV]:	6
Diffuser type:	transparent	Plik LDT:	Download

QUEST LED EVO EVEREST 24300LM I CL. IP66 840 MW (85D) 150W

DETAILED CARD

TECHNICAL PICTURES

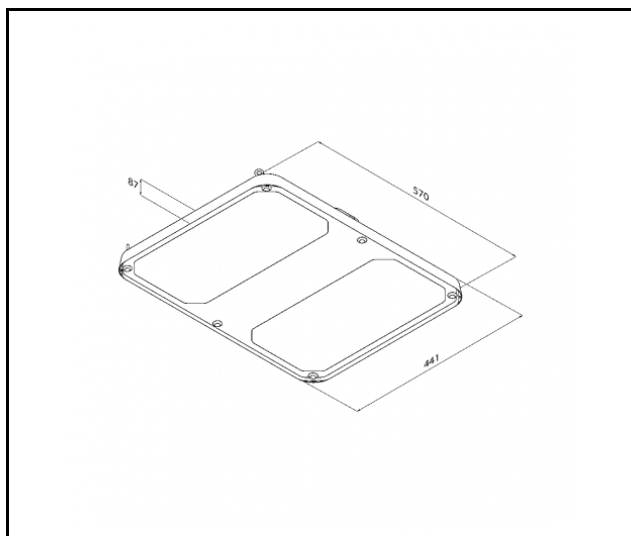

QUEST LED EVO EVEREST 24300LM | CL. IP66 840 MW (85D) 150W

DETAILED CARD

ACCESSORIES AVAILABLE

index	Name
831720	QUEST EVO EVEREST protective grid RAL9003
831713	QUEST EVO EVEREST protective grid RAL7016
831782	QUEST EVO EVEREST holder AW RAL7016
831775	QUEST EVO EVEREST holder RCR RAL7016
831768	QUEST EVO EVEREST luminaire connector - separate suspension RAL7016
831751	QUEST EVO EVEREST luminaire connector - common suspension RAL7016
831744	QUEST EVO EVEREST holder NT RAL7016
831737	QUEST EVO EVEREST recessed frame RAL7016

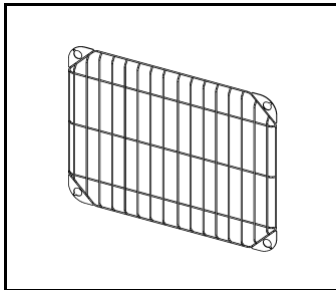

QUEST EVO EVEREST protective grid RAL9003 (831720)

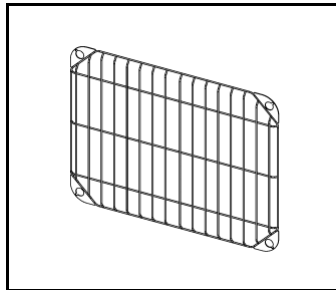

QUEST EVO EVEREST protective grid RAL7016 (831713)

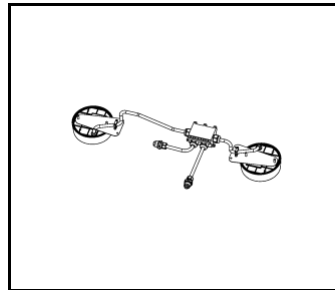

QUEST EVO EVEREST holder AW RAL7016 (831782)

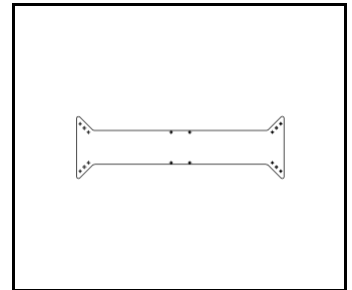

QUEST EVO EVEREST holder RCR RAL7016 (831775)

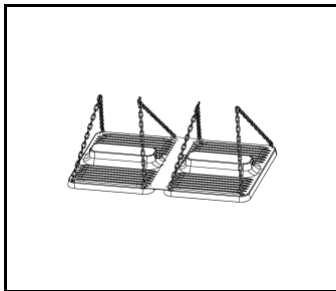

QUEST EVO EVEREST luminaire connector - separate suspension RAL7016 (831768)

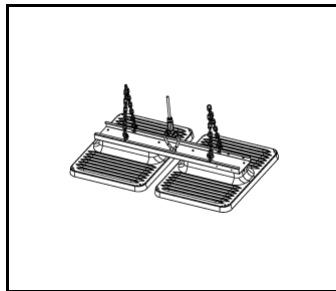

QUEST EVO EVEREST luminaire connector - common suspension RAL7016 (831751)

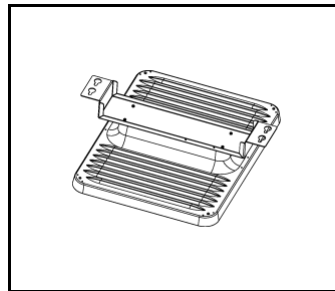

QUEST EVO EVEREST holder NT RAL7016 (831744)

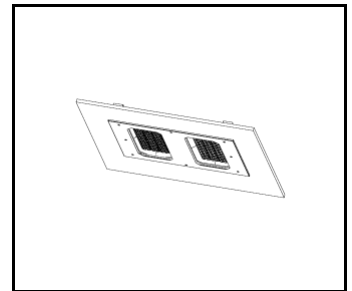

QUEST EVO EVEREST recessed frame RAL7016 (831737)

Card creation date: 11 September 2025

The company reserves the right to make design changes or upgrades in the presented product. Product data sheet does not constitute an offer. * Parameter tolerance is +/- 10%

 This product is a subject to electric and electronic waste equipment regulations (WEEE).

 Certificate CE - Nr: 98/2025