

CONSTELIA LED R 9400LM 730 RM7 IP66 II CL. 2DIM IK09 (70W)

DETAILED CARD



TECHNICAL PARAMETERS

Index:	809323
Ingress protection:	IP66
Impact resistance:	IK09
Rated power of the luminaire [W]*:	70
Luminous flux [lm]*:	9400
Colour temperature [K]:	3000
Color rendering index (Ra) >:	70
Optics:	RM7
Control:	Yes + 5-stage power reduction

CHARACTERISTICS

Constelia LED R is a new generation of stylised LED park-and-ride luminaires. It uses directional multi-lens matrices, made of PMMA, with each lens having dedicated optics, ensuring the light characteristics remain consistent over time. The luminaire's design ensures that the luminaire's internal chamber remains sealed. As standard, the luminaire offers tool-free access to the electrical equipment, which, if desired and to protect against vandalism or uncontrolled opening, can optionally be permanently secured with screws. The luminaire offers rapid and convenient serviceability, allowing one integrated component to be replaced without the need to dismantle the entire luminaire and make soldered or screwed connections. No on-site service work is required. Simply replace the module with a spare (accessory) close the luminaire and the service work is then carried out on site: at the luminaire owner's facility or sent back to the manufacturer's service centre. The luminaire body and handle are made of die-cast aluminium, powder-coated black and have a very high IP66 ingress protection and IK09 mechanical shock resistance.

Accessories available: NTC overheating protection; fully programmable DALI driver; luminaire CLO and Autonomous 5-step power reduction functions available; connection terminals; tool-free access protected by a knife disconnect switch to de-energise the integral module if the compartment is opened.

Additional options: stylised glazing to transform the external appearance of the luminaire, ZHAGA connector (ZhagaBook 18); interfacing with control systems, anti-vandal protection with screws; additional SPI10kV protection outside the power supply, on/off power supply without power reduction; design with cable terminated with quick connector; painting in any RAL colour. Certifications: CE, RoHS, ENEC, ENEC+, Zhaga-D4i.

APPLICATION

Outdoor areas of places such as town halls, libraries, town halls, health facilities, schools, kindergartens, public gardens, streets, pavements, recreational areas: playing fields, playgrounds, cycle paths, historical sites, old towns.

CONSTELIA LED R 9400LM 730 RM7 IP66 II CL. 2DIM IK09 (70W)

DETAILED CARD

TECHNICAL PARAMETERS TABLE

Index:	809323	Colour of the body:	black
Category type:	Park and city lighting	Dimensions (H/W/T/S) [mm]:	425/425/765
Category of application:	parkings and bicycle paths	Mounting dimensions [mm]:	ø42
Light source:	LED module	Impact resistance:	IK09
Rated power of the luminaire [W]:	70	Ingress protection:	IP66
Luminous flux [lm]:	9400	Mounting version:	suspended
Supply voltage [V]:	220-240	Working temperature [°C]:	from -40 to +50
Luminous efficacy [lm/W]:	134	DIMM 1-10V:	yes
Energy efficiency class:	D	Control:	Yes + 5-stage power reduction
Electrical protection class:	II	Wire type:	HO7 RNF-2x1
Colour temperature [K]:	3000	Cable length [m]:	1.50
Color rendering index (Ra) >:	70	Number on the palette [pcs]:	8
Power factor:	0.98	Net weight [kg]:	7
Surge protection [kV]:	10	Warranty [years]:	5 z możliwością przedłużenia do 10
Diffuser material:	tempered glass	CE certificate:	88/2025
Diffuser type:	transparent	ENEC Certificate:	0431/ENEC/25; 0151/ENEC+/25
Optics:	RM7	Zhaga-D4i:	ZG448511062025
Optics material:	PMMA + PC	Environmental Product Declaration (EPD):	683/2024
Material of the body:	powder coated aluminium	Manual:	Download PDF

LIGHT CURVES

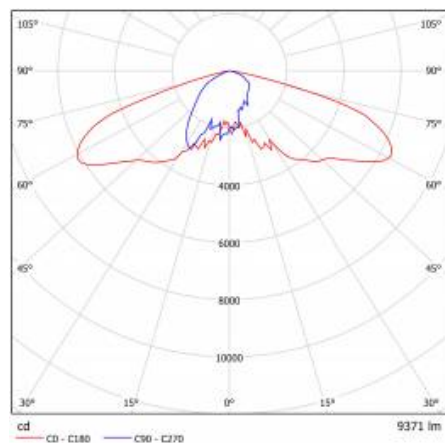

CONSTELIA LED R 9400LM 730 RM7 IP66 II CL. 2DIM IK09 (70W)

DETAILED CARD

TECHNICAL PICTURES

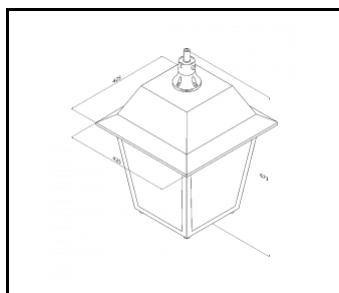

CONSTELIA LED R 9400LM 730 RM7 IP66 II CL. 2DIM IK09 (70W)

DETAILED CARD

ACCESSORIES AVAILABLE

index	Name
809972	Constelia LED milky diffuser
809989	Constelia LED frosted diffuser
809996	Constelia LED transparent diffuser
810992	Constelia LED sandblasted diffuser
809330	Constelia LED backshield



Constelia LED frosted diffuser (809989)



Constelia LED transparent diffuser (809996)

Card creation date: 09 July 2025

The company reserves the right to make design changes or upgrades in the presented product. Product data sheet does not constitute an offer. * Parameter tolerance is +/- 10%



This product is a subject to electric and electronic waste equipment regulations (WEEE).



Certificate CE - Nr: 88/2025