

CONSTELIA LED 5100LM 740 RM7 IP66 II CL. DALI IK09 (39W)

DETAILED CARD



TECHNICAL PARAMETERS

Index:	809149
Ingress protection:	IP66
Impact resistance:	IK09
Rated power of the luminaire [W]*:	39
Luminous flux [lm]*:	5100
Colour temperature [K]:	4000
Color rendering index (Ra) >:	70
Optics:	RM7
Control:	Yes + 5-stage power reduction

CHARACTERISTICS

Constelia LED is a new generation of stylised LED park-and-ride luminaires. It uses directional multi-lens matrices, made of PMMA, with each lens having dedicated optics, ensuring the light characteristics remain consistent over time. The luminaire's design ensures that the luminaire's internal chamber remains sealed. As standard, the luminaire offers tool-free access to the electrical equipment, which, if desired and to protect against vandalism or uncontrolled opening, can optionally be permanently secured with screws. The luminaire offers rapid and convenient serviceability, allowing one integrated component to be replaced without the need to dismantle the entire luminaire and make soldered or screwed connections. No on-site service work is required. Simply replace the module with a spare (accessory) close the luminaire and the service work is then carried out on site: at the luminaire owner's facility or sent back to the manufacturer's service centre. The luminaire body and handle are made of die-cast aluminium, powder-coated black and have a very high IP66 ingress protection and IK09 mechanical shock resistance.

Accessories available: NTC overheating protection; fully programmable DALI driver; luminaire CLO and Autonomous 5-step power reduction functions available; connection terminals; tool-free access protected by a knife disconnect switch to de-energise the integral module if the compartment is opened.

Additional options: stylised glazing to transform the external appearance of the luminaire, ZHAGA connector (ZhagaBook 18); interfacing with control systems, anti-vandal protection with screws; additional SPI10kV protection outside the power supply, on/off power supply without power reduction; design with cable terminated with quick connector; painting in any RAL colour. Certifications: CE, RoHS, ENEC, ENEC+, Zhaga-D4i.

APPLICATION

Outdoor areas of places such as town halls, libraries, town halls, health facilities, schools, kindergartens, public gardens, streets, pavements, recreational areas: playing fields, playgrounds, cycle paths, historical sites, old towns.

CONSTELIA LED 5100LM 740 RM7 IP66 II CL. DALI IK09 (39W)

DETAILED CARD

TECHNICAL PARAMETERS TABLE

Index:	809149	Dimensions (H/W/T/S) [mm]:	425/425/827
EAN:	5905963809149	Mounting dimensions [mm]:	ø70
Category type:	Park and city lighting	Impact resistance:	IK09
Category of application:	parkings and bicycle paths	Ingress protection:	IP66
Light source:	LED module	Mounting version:	top
Rated power of the luminaire [W]:	39	Lateral surface (SCx) [m2]:	0.08
Luminous flux [lm]:	5100	Working temperature [°C]:	from -40 to +50
Supply voltage [V]:	220-240	DIMM DALI:	yes
Luminous efficacy [lm/W]:	131	Control:	Yes + 5-stage power reduction
Energy efficiency class:	D	Wire type:	HO7 RNF-2x1
Electrical protection class:	II	Cable length [m]:	1.50
Colour temperature [K]:	4000	Number on the palette [pcs]:	8
Color rendering index (Ra) >:	70	Net weight [kg]:	7
Power factor:	0.93	Warranty [years]:	5 z możliwością przedłużenia do 10
Surge protection [kV]:	10	CE certificate:	87/2025
Diffuser material:	tempered glass	ENEC Certificate:	0431/ENEC/25; 0151/ENEC+/25
Diffuser type:	transparent	Zhaga-D4i:	ZG448511062025
Optics:	RM7	Environmental Product Declaration (EPD):	683/2024
Optics material:	PMMA + PC	Manual:	Download PDF
Material of the body:	powder coated aluminium	ISO Certificates:	9001:2015, 14001:2015, 45001:2018, 50001:2018
Colour of the body:	black		

LIGHT CURVES



CONSTELIA LED 5100LM 740 RM7 IP66 II CL. DALI IK09 (39W)

DETAILED CARD
TECHNICAL PICTURES

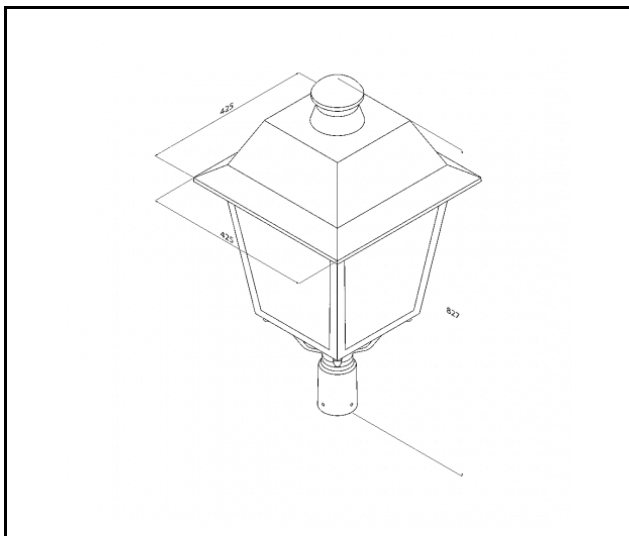

CONSTELIA LED 5100LM 740 RM7 IP66 II CL. DALI IK09 (39W)

DETAILED CARD

ACCESSORIES AVAILABLE

index	Name
809972	Constelia LED milky diffuser
809989	Constelia LED frosted diffuser
809996	Constelia LED transparent diffuser
810992	Constelia LED sandblasted diffuser
809330	Constelia LED backshield



Constelia LED frosted
diffuser (809989)



Constelia LED transparent
diffuser (809996)

Card creation date: 09 July 2025

The company reserves the right to make design changes or upgrades in the presented product. Product data sheet does not constitute an offer. * Parameter tolerance is +/- 10%



This product is a subject to electric and electronic waste equipment regulations (WEEE).



Certificate CE - Nr: 87/2025