

QUEST LED EVO M ENDURA 19400LM I CL. IP67 740 30D 111W

DETAILED CARD



TECHNICAL PARAMETERS

Index:	844119
Ingress protection:	IP67
Rated power of the luminaire [W]*:	111
Luminous flux [lm]*:	19400
Colour temperature [K]:	4000
Color rendering index (Ra) >:	70
SDCM:	3
Electrical protection class:	I
Energy efficiency class:	B
Material of the body:	aluminium

CHARACTERISTICS

The Endura version of Quest LED EVO M luminaires, their high-bay versions: surface-mounted Quest LED EVO M HB NT and suspended Quest LED EVO M HB Z are extremely efficient premium class floodlights, manufactured in Poland, adapted to operate at high temperatures (up to 50 degrees C). The body is made of die-cast aluminium, powder coated, without an external heat sink and ribs that make it difficult to keep clean. The basic version has a steel arm with a 7.5-degree scale, while the highbay endura (HB NT) version is available in surface-mounted and suspended (HB Z) versions. The diffuser is made of tempered glass, under which there are LEDs with the highest efficiency. Various types of optics, especially asymmetrical ones, provide great freedom in selecting the right solution for a specific application. Thanks to the highest tightness rating on the market (IP67) and maximum impact resistance (IK10), it will perform well in all conditions, regardless of the weather and installation location. The new version of the renowned and proven QUEST model in its smallest version offers even better lighting parameters, achieving an efficiency of over 170 lm/W. The Endura variant also meets the requirements of PN-EN 60598-2 part 5, which allows them to be classified as illumination projectors. This means complete freedom of installation in any position, with 360° rotation and resistance to strong winds – an advantage not offered by other floodlights. An additional advantage for contractors is the sealed quick connector – an innovative solution that eliminates traditional, time-consuming connection methods (screws). Thanks to an intuitive system of coloured latches, connector installation is simple, quick and tool-free. The accessory kit includes: pole mounting brackets (basic version); frame for flush mounting, e.g. in shelters (basic version); light pollution reduction screens (basic version); protective grilles in two colours with different degrees of light reduction (white RAL7016: 4%, body colour RAL7016: 8%). The models can be equipped with an external motion and twilight sensor.

APPLICATION

Quest LED EVO M Endura, Quest LED EVO M Endura HB NT and Endura HB Z are used in: lighting educational, administrative and institutional facilities, halls, garages, passageways, warehouses, shops, the food industry and commercial and service facilities related to food products illumination of buildings, small sports fields, open spaces and car parks, environments with elevated ambient temperatures (up to 50 degrees C). Installation options: as a floodlight, on poles and masts, on building facades, as a surface-mounted highbay (HB NT version), suspended highbay (HB Z version), flush-mounted (e.g. shelters). The product is particularly well suited for use in factories and production halls as well as large-area warehouses, especially in areas exposed to high temperatures.

QUEST LED EVO M ENDURA 19400LM I CL. IP67 740 30D 111W

DETAILED CARD

TECHNICAL PARAMETERS TABLE

Index:	844119	Mounting dimensions [mm]:	400
EAN:	5905963844119	Ingress protection:	IP67
Light source:	LED	Mounting version:	surface
Rated power of the luminaire [W]:	111	Working temperature [°C]:	from -20 to +50
Supply voltage [V]:	220 - 240	The number of implement units:	2
Surge protection [kV]:	6	Number on the palette [pcs]:	48
Frequency [Hz]:	0/50/60	Category type:	floodlights
Luminous flux [lm]:	19400	AC voltage range [V]:	198-264
Luminous efficacy [lm/W]:	175	DC voltage range [V]:	176-280
Energy efficiency class:	B	Impact resistance:	IK10
Electrical protection class:	I	Net weight [kg]:	8
Colour temperature [K]:	4000	LED lifespan L70B50 [h]:	162000
Color rendering index (Ra) >:	70	LED lifespan L80B10 [h]:	101000
SDCM:	3	LED lifespan L90B10 [h]:	47000
Beam angle [°]:	30	Warranty [years]:	5
Diffuser material:	glass	CE certificate:	77/2025
Diffuser type:	transparent	Environmental Product Declaration (EPD):	816/2025
Material of the body:	aluminium	Manual:	Download PDF
Colour of the body:	RAL7016	Category of application:	industrial
Dimensions (H/W/T/S) [mm]:	383/550/57	Pliik LDT:	Download

QUEST LED EVO M ENDURA 19400LM I CL. IP67 740 30D 111W

DETAILED CARD
TECHNICAL PICTURES

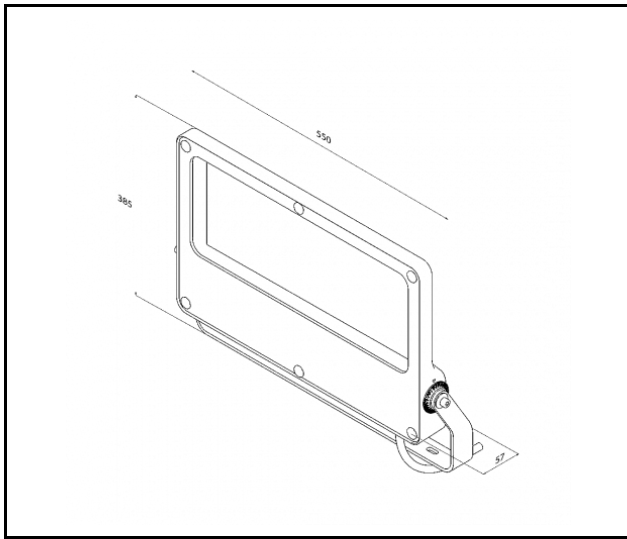

QUEST LED EVO M ENDURA 19400LM I CL. IP67 740 30D 111W

DETAILED CARD

ACCESSORIES AVAILABLE

index	Name
840463	Quest LED Evo M recessed frame RAL7016
840432	QUEST LED EVO M protective grid RAL7016
840494	QUEST LED EVO M cover RAL7016
840074	QUEST LED EVO M protective grid RAL9003
840401	QUEST LED EVO M/L pole holder 1x
840418	QUEST LED EVO M/L pole holder 2x
840098	QUEST LED EVO wall mount RAL7016 1m
840388	QUEST LED EVO M/L RCR set 1x



Quest LED Evo M recessed frame RAL7016 (840463)



QUEST LED EVO M protective grid RAL7016 (840432)



QUEST LED EVO M cover RAL7016 (840494)



QUEST LED EVO M protective grid RAL9003 (840074)



QUEST LED EVO M/L pole holder 1x (840401)



QUEST LED EVO M/L pole holder 2x (840418)



QUEST LED EVO wall mount RAL7016 1m (840098)



QUEST LED EVO M/L RCR set 1x (840388)

Card creation date: 05 August 2025

The company reserves the right to make design changes or upgrades in the presented product. Product data sheet does not constitute an offer. * Parameter tolerance is +/- 10%

 This product is a subject to electric and electronic waste equipment regulations (WEEE).

 Certificate CE - Nr: 77/2025