

DOT CR LED EVO 3W 450LM HB IP65/IP20 3H NM AT RAL9005

DETAILED CARD



TECHNICAL PARAMETERS

Index:	236464
Ingress protection:	IP20 / IP65
Impact resistance:	IK07
Rated power of the luminaire [W]*:	3
Luminous flux [lm]*:	450
Colour temperature [K]:	4000
Material of the body:	PC
Diffuser material:	PMMA
Diffuser type:	lens
Optics material:	PC

CHARACTERISTICS

Recessed 3W standalone emergency luminaire with integrated energy-efficient LED light module with 450lm light output. Body made of polycarbonate (PC). Optics available in 4 variants: general wide, general narrow, corridor wide, corridor narrow. DOT LED EVO has a built-in Li-ion battery, with an emergency operating time of 1h or 3h. The luminaire is available in an autotest (AT) version. Available in white or black.

APPLICATION

A self-contained emergency luminaire whose main use is to illuminate escape routes and fire protection equipment following a mains power failure. Particularly recommended where it is necessary to install emergency lighting as part of the modernisation of the existing installation. Depending on the optics used, the luminaire can illuminate: escape routes (with corridor distribution) or be used as panic lighting with standard general distribution.

DOT CR LED EVO 3W 450LM HB IP65/IP20 3H NM AT RAL9005

DETAILED CARD

TECHNICAL PARAMETERS TABLE

Index:	236464	Colour of the body:	black
Light source:	LED module	Dimensions (H/W/T/S) [mm]:	ø135/30
Rated power of the luminaire [W]:	3	Mounting dimensions [mm]:	ø100
Supply voltage [V]:	230	Impact resistance:	IK07
Frequency [Hz]:	50-60	Ingress protection:	IP20 / IP65
Luminous flux [lm]:	450	Mounting version:	recessed
Luminous efficacy [lm/W]:	150	Working temperature [°C]:	from +5 to +35
Electrical protection class:	I	Emergency lighting [h]:	3
Colour temperature [K]:	4000	Net weight [kg]:	0.430
LED lifespan L70B50 [h]:	167000	Category type:	emergency lighting
Beam angle [°]:	CRHB	Autotest:	yes
Exchangeable source:	yes	Operating mode:	NM
Battery:	Li-Ion	Light distribution type:	general narrow
Battery capacity [mAh]:	4000	LED lifespan L80B10 [h]:	101000
Diffuser material:	PMMA	LED lifespan L90B10 [h]:	49500
Diffuser type:	lens	Warranty [years]:	5
Diffuser colour:	transparent	CE certificate:	42/2025
Optics material:	PC	Manual:	Download PDF
Material of the body:	PC	Plik LDT:	Download

LIGHT CURVES

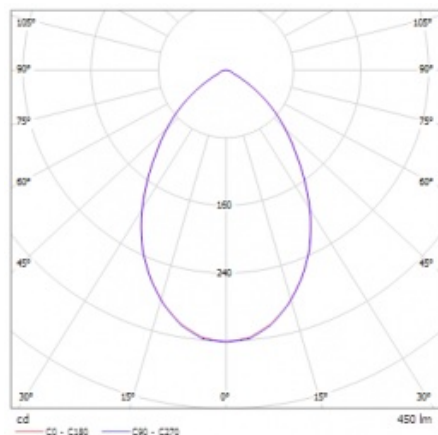

DOT CR LED EVO 3W 450LM HB IP65/IP20 3H NM AT RAL9005

DETAILED CARD

TECHNICAL PICTURES

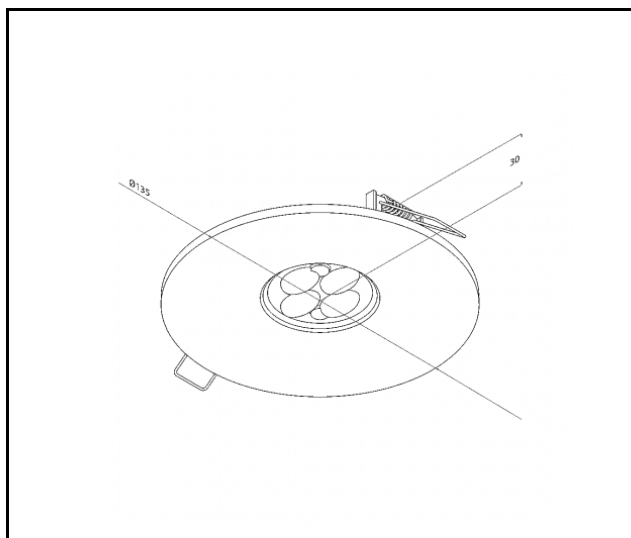

Card creation date: 20 May 2025

The company reserves the right to make design changes or upgrades in the presented product. Product data sheet does not constitute an offer. * Parameter tolerance is +/- 10%



This product is a subject to electric and electronic waste equipment regulations (WEEE).



Certificate CE - Nr: 42/2025