

TERRA BALANCE Z 600X600MM 4950LM 830 GRAYD 70D (50W)

DETAILED CARD



TECHNICAL PARAMETERS

Index:	805448
Rated power of the luminaire [W]*:	50
Luminous flux [lm]*:	4950
Colour temperature [K] - range:	3000
Material of the body:	PET + steel
Colour of the body:	medium gray
Dimensions (H/W/T/S) [mm]:	600/600/44
Mounting version:	suspended

CHARACTERISTICS

Terra Balance is a modern solution combining advanced acoustic features with professional lighting, made from an environmentally friendly material - recycled PET. The product is an innovative response to contemporary interior design needs, where both functionality and aesthetics matter. The luminaires are made from high quality recycled PET felt. The material is characterised by its lightweight and durable structure, which was obtained from recycled plastic bottles. This makes the product fully ecological and environmentally friendly. Terra Balance effectively absorbs sound waves, reducing echoes and improving speech intelligibility. The product works well in spaces with hard surfaces such as glass, concrete or wood interiors. The luminaires are equipped with a compact LED louver that provides a low glare factor (UGR 12-19). The lamps are available in colour temperatures: 3000K, 4000K and Tunable White in the range 2700-6500K. There is a choice of 6 basic colours, with the option of ordering 6 further colour variations. Luminaires made of PET are characterised by exceptional resistance to moisture and mechanical damage. The material is easy to clean and fully recyclable. The product is distinguished by its modern design and wide range of shapes and colours. It is compatible with DALI control systems and offers a variety of mounting options, including: pendant panels, acoustic ceilings, floor standing lamps and wall fittings. Terra Balance brings many benefits to users: it improves acoustic comfort, optimises lighting, provides an ecological solution and is highly functional. The product meets the highest standards in design, acoustics and sustainability.

APPLICATION

Terra Balance is ideal for a variety of spaces including: open plan offices, meeting rooms, restaurants, cafes, schools, colleges and residential spaces.

TERRA BALANCE Z 600X600MM 4950LM 830 GRAYD 70D (50W)

DETAILED CARD

TECHNICAL PARAMETERS TABLE

Index:	805448	Light distribution type:	symmetric
EAN:	5905963805448	Surge protection [kV]:	1
Category type:	decorative fixtures	Diffuser material:	PC
Category of application:	architectural, HoReCa, commercial facilities	Diffuser type:	matrix led
Light source:	LED module	Optics:	lens
Rated power of the luminaire [W]:	50	Optics material:	PC
Luminous flux [lm]:	4950	Material of the body:	PET + steel
Supply voltage [V]:	220-240	Colour of the body:	medium gray
Frequency [Hz]:	50-60	Dimensions (H/W/T/S) [mm]:	600/600/44
Luminous efficacy [lm/W]:	99	Ingress protection:	IP20
Energy efficiency class:	E	Mounting version:	suspended
Electrical protection class:	II	Working temperature [°C]:	35
Colour temperature [K] - range:	3000	Dimensions of single box [mm]:	600
Color rendering index (Ra) >:	80	Number on the palette [pcs]:	32
SDCM:	3	Net weight [kg]:	5.300
UGR (4H8H):	<19	Warranty [years]:	5
LED lifespan L70B50 [h]:	153000	CE certificate:	22/2025
LED lifespan L80B10 [h]:	96000	Manual:	Download PDF
LED lifespan L90B10 [h]:	46000	ISO Certificates:	9001:2015, 14001:2015, 45001:2018, 50001:2018
Beam angle [°]:	70	Plik LDT:	Download

TERRA BALANCE Z 600X600MM 4950LM 830 GRAYD 70D (50W)

DETAILED CARD

TECHNICAL PICTURES

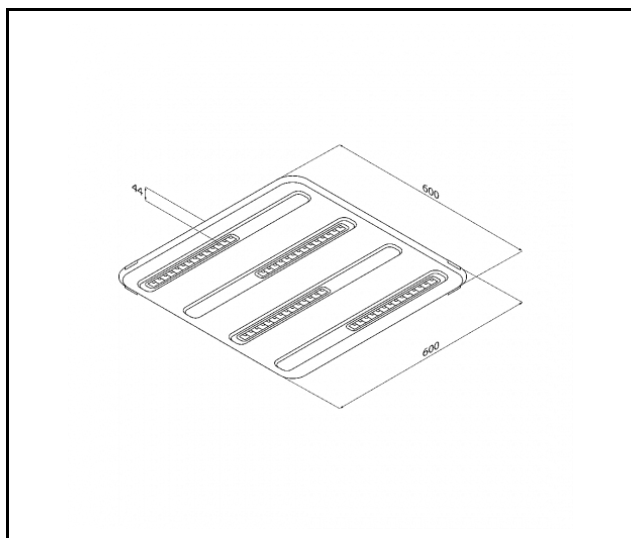

TERRA BALANCE Z 600X600MM 4950LM 830 GRAYD 70D (50W)

DETAILED CARD

ACCESSORIES AVAILABLE

index	Name
806919	Terra Balance connector set 2 pcs BLUE02
806926	Terra Balance Connector Set 2pcs GRAYL
806933	Terra Balance connector set 2pcs GRAYD
806940	Terra Balance connector set 2pcs GRAYM
806957	Terra Balance connector set 2 pcs BRN01
806964	Terra Balance coupling set 2 pcs MTCH
807015	Terra Balance - PET panel colour chart



Terra Balance connector set 2 pcs BLUE02 (806919)



Terra Balance Connector Set 2pcs GRAYL (806926)



Terra Balance connector set 2pcs GRAYD (806933)



Terra Balance connector set 2pcs GRAYM (806940)



Terra Balance connector set 2 pcs BRN01 (806957)



Terra Balance coupling set 2 pcs MTCH (806964)



Terra Balance - PET panel colour chart (807015)

Card creation date: 18 March 2026

The company reserves the right to make design changes or upgrades in the presented product. Product data sheet does not constitute an offer. * Parameter tolerance is +/- 10%

 This product is a subject to electric and electronic waste equipment regulations (WEEE).

 Certificate CE - Nr: 22/2025