

# TERRA BALANCE Z 600X600MM 2850LM 830 GRAYL 70D (27W)

DETAILED CARD



## TECHNICAL PARAMETERS

<b>Index:</b>	805196
<b>Rated power of the luminaire [W]*:</b>	27
<b>Luminous flux [lm]*:</b>	2850
<b>Colour temperature [K] - range:</b>	3000
<b>Material of the body:</b>	PET + steel
<b>Colour of the body:</b>	light gray
<b>Dimensions (H/W/T/S) [mm]:</b>	600/600/44
<b>Mounting version:</b>	suspended

## CHARACTERISTICS

Terra Balance is a modern solution combining advanced acoustic features with professional lighting, made from an environmentally friendly material - recycled PET. The product is an innovative response to contemporary interior design needs, where both functionality and aesthetics matter. The luminaires are made from high quality recycled PET felt. The material is characterised by its lightweight and durable structure, which was obtained from recycled plastic bottles. This makes the product fully ecological and environmentally friendly. Terra Balance effectively absorbs sound waves, reducing echoes and improving speech intelligibility. The product works well in spaces with hard surfaces such as glass, concrete or wood interiors. The luminaires are equipped with a compact LED louver that provides a low glare factor (UGR 12-19). The lamps are available in colour temperatures: 3000K, 4000K and Tunable White in the range 2700-6500K. There is a choice of 6 basic colours, with the option of ordering 6 further colour variations. Luminaires made of PET are characterised by exceptional resistance to moisture and mechanical damage. The material is easy to clean and fully recyclable. The product is distinguished by its modern design and wide range of shapes and colours. It is compatible with DALI control systems and offers a variety of mounting options, including: pendant panels, acoustic ceilings, floor standing lamps and wall fittings. Terra Balance brings many benefits to users: it improves acoustic comfort, optimises lighting, provides an ecological solution and is highly functional. The product meets the highest standards in design, acoustics and sustainability.

## APPLICATION

Terra Balance is ideal for a variety of spaces including: open plan offices, meeting rooms, restaurants, cafes, schools, colleges and residential spaces.

# TERRA BALANCE Z 600X600MM 2850LM 830 GRAYL 70D (27W)

DETAILED CARD

## TECHNICAL PARAMETERS TABLE

<b>Index:</b>	805196	<b>Light distribution type:</b>	symmetric
<b>EAN:</b>	5905963805196	<b>Surge protection [kV]:</b>	1
<b>Category type:</b>	decorative fixtures	<b>Diffuser material:</b>	PC
<b>Category of application:</b>	architectural, HoReCa, commercial facilities	<b>Diffuser type:</b>	matrix led
<b>Light source:</b>	LED module	<b>Optics:</b>	lens
<b>Rated power of the luminaire [W]:</b>	27	<b>Optics material:</b>	PC
<b>Luminous flux [lm]:</b>	2850	<b>Material of the body:</b>	PET + steel
<b>Supply voltage [V]:</b>	220-240	<b>Colour of the body:</b>	light gray
<b>Frequency [Hz]:</b>	50-60	<b>Dimensions (H/W/T/S) [mm]:</b>	600/600/44
<b>Luminous efficacy [lm/W]:</b>	106	<b>Ingress protection:</b>	IP20
<b>Energy efficiency class:</b>	E	<b>Mounting version:</b>	suspended
<b>Electrical protection class:</b>	II	<b>Working temperature [°C]:</b>	35
<b>Colour temperature [K] - range:</b>	3000	<b>Dimensions of single box [mm]:</b>	600
<b>Color rendering index (Ra) &gt;:</b>	80	<b>Number on the palette [pcs]:</b>	32
<b>SDCM:</b>	3	<b>Net weight [kg]:</b>	5.150
<b>UGR (4H8H):</b>	<19	<b>Warranty [years]:</b>	5
<b>LED lifespan L70B50 [h]:</b>	153000	<b>CE certificate:</b>	<a href="#">22/2025</a>
<b>LED lifespan L80B10 [h]:</b>	96000	<b>Manual:</b>	<a href="#">Download PDF</a>
<b>LED lifespan L90B10 [h]:</b>	46000	<b>ISO Certificates:</b>	9001:2015, 14001:2015, 45001:2018, 50001:2018
<b>Beam angle [°]:</b>	70	<b>Plik LDT:</b>	<a href="#">Download</a>

# TERRA BALANCE Z 600X600MM 2850LM 830 GRAYL 70D (27W)

DETAILED CARD

TECHNICAL PICTURES

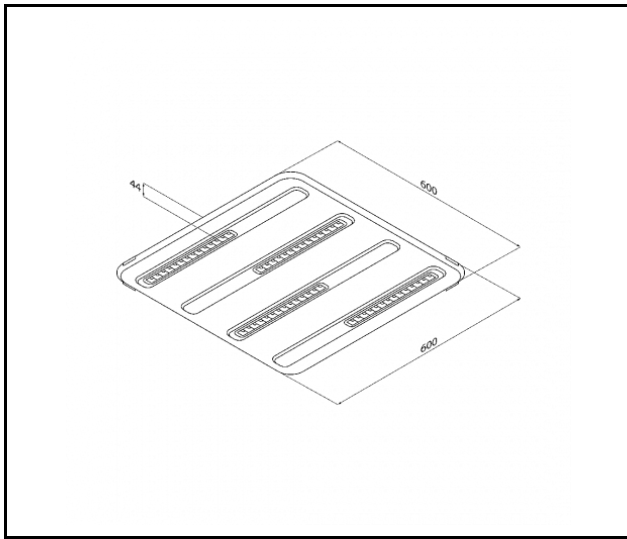

# TERRA BALANCE Z 600X600MM 2850LM 830 GRAYL 70D (27W)

DETAILED CARD

## ACCESSORIES AVAILABLE

index	Name
806919	Terra Balance connector set 2 pcs BLUE02
806926	Terra Balance Connector Set 2pcs GRAYL
806933	Terra Balance connector set 2pcs GRAYD
806940	Terra Balance connector set 2pcs GRAYM
806957	Terra Balance connector set 2 pcs BRN01
806964	Terra Balance coupling set 2 pcs MTCH
807015	Terra Balance - PET panel colour chart



Terra Balance connector set 2 pcs BLUE02 (806919)



Terra Balance Connector Set 2pcs GRAYL (806926)



Terra Balance connector set 2pcs GRAYD (806933)



Terra Balance connector set 2pcs GRAYM (806940)



Terra Balance connector set 2 pcs BRN01 (806957)



Terra Balance coupling set 2 pcs MTCH (806964)



Terra Balance - PET panel colour chart (807015)

Card creation date: 18 March 2026

The company reserves the right to make design changes or upgrades in the presented product. Product data sheet does not constitute an offer. \* Parameter tolerance is +/- 10%

 This product is a subject to electric and electronic waste equipment regulations (WEEE).

 Certificate CE - Nr: 22/2025