

FACTOR LED 4M 68000LM 740 RM7 IP66 SH (480W) C5-M

DETAILED CARD



TECHNICAL PARAMETERS

Index:	682810
Ingress protection:	IP66
Impact resistance:	IK09
Rated power of the luminaire [W]*:	480
Luminous flux [lm]*:	68000
Colour temperature [K]:	4000
Color rendering index (Ra) >:	70
SDCM:	5
Electrical protection class:	I
Energy efficiency class:	C

CHARACTERISTICS

Factor Led C5-M (corrosion protection in harsh industrial and marine environments) is the latest generation of high-powered floodlight with impressive lumen output. It is characterised not only by very high luminous efficiency, but also by high IP66 sealing and IK09 impact resistance. These parameters were achieved thanks to the branded components used, the robust housing made of cast aluminium LM-6 (aluminium-silicon alloy) and the use of a passive lamp cooling system, which allows excess heat generation to be dissipated during lamp operation. In the C5-M version, the paint coating plays an even more important role. The Factor Led has the advantage of being very quick and easy to install. The lightweight steel arm is attached to the supporting structure (wall, column) and then the light modules are plugged in. On one bracket, the installer can plug in a lamp containing 1 to 4 such modules.

APPLICATION

Ports, wharves, shipyards, oil rigs and offshore infrastructure, chemical industry and refineries, bridges and infrastructure exposed to marine conditions, lighting on ships and ferries, industrial areas, playing fields, airports, car parks with high humidity and salinity.

FACTOR LED 4M 68000LM 740 RM7 IP66 SH (480W) C5-M

DETAILED CARD

TECHNICAL PARAMETERS TABLE

Index:	682810	Material of the body:	aluminium
EAN:	5905963682810	Colour of the body:	RAL7016
Light source:	LED module	Dimensions (H/W/T/S) [mm]:	774/425/340
Rated power of the luminaire [W]:	480	Mounting dimensions [mm]:	310
Luminous flux [lm]:	68000	Impact resistance:	IK09
Supply voltage [V]:	220-240	Ingress protection:	IP66
Frequency [Hz]:	47-63	Mounting version:	top
Luminous efficacy [lm/W]:	142	Working temperature [°C]:	from -40 to +45
Energy efficiency class:	C	Dimensions of single box [mm]:	430
Electrical protection class:	I	Number on the palette [pcs]:	18
Colour temperature [K]:	4000	Net weight [kg]:	23.240
Color rendering index (Ra) >:	70	Version:	4 modules
SDCM:	5	Light distribution type:	RM7
Power factor:	0.98	Corrosivity category:	C5-M
LED lifespan L70B50 [h]:	156000	Warranty [years]:	5
LED lifespan L80B10 [h]:	98000	CE certificate:	262/2023
LED lifespan L90B10 [h]:	47000	ENEC Certificate:	0404/ENEC/25
Beam angle [°]:	RM7	Environmental Product Declaration (EPD):	816/2025
Surge protection [kV]:	6	Manual:	Download PDF
Diffuser material:	tempered glass	Pliik LDT:	Download

LIGHT CURVES

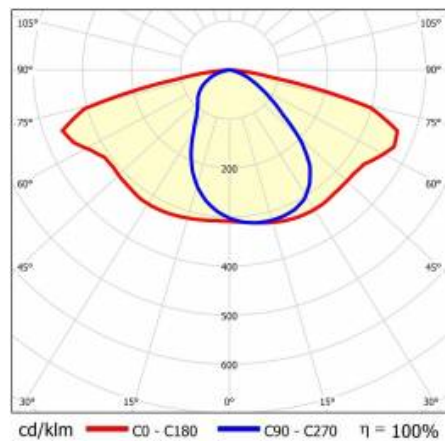

FACTOR LED 4M 68000LM 740 RM7 IP66 SH (480W) C5-M

DETAILED CARD

TECHNICAL PICTURES

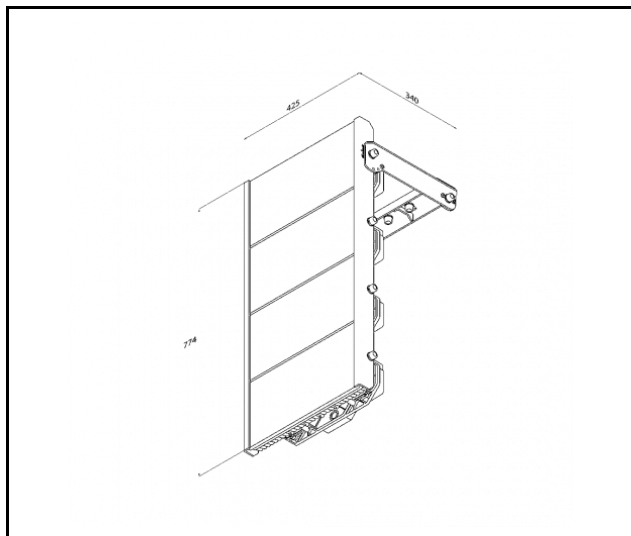

Card creation date: 19 February 2025

The company reserves the right to make design changes or upgrades in the presented product. Product data sheet does not constitute an offer. * Parameter tolerance is +/- 10%



This product is a subject to electric and electronic waste equipment regulations (WEEE).



Certificate CE - Nr: 262/2023