

TUBA IP69K GLASS 630MM 4300LM 840 LS2 (1F) VW IK06 26W

DETAILED CARD



TECHNICAL PARAMETERS

Index:	775116
Ingress protection:	IP69K
Impact resistance:	IK06
Rated power of the luminaire [W]*:	26
Luminous flux [lm]*:	4300
Colour temperature [K]:	4000
Color rendering index (Ra) >:	80
SDCM:	3
Electrical protection class:	I
Energy efficiency class:	B

CHARACTERISTICS

Tuba IP69K is a cylindrical luminaire for special tasks - where other solutions fail. Designed for extreme conditions, it combines superior sealing, chemical resistance and mechanical durability. Meeting the standard for IP69K means full protection against dust (IP6X) and complete resistance to water at extremely high pressure (100 bar) at 80°C (IPX9K). This makes the luminaire ideal for areas requiring intensive cleaning, including with powerful water jets and detergents. The IP69K tube is designed to operate in the most demanding conditions. Made from chemically resistant materials: PMMA and extremely resistant borosilicate glass - ensuring exceptional durability even in aggressive industrial environments. The turned acid-resistant steel endcap eliminates the risk of corrosion, and its resistance to ammonia and zoonotic gases makes it ideal for livestock and processing facilities. Thanks to the decompression valve, the luminaire easily withstands rapid temperature changes, and the highest IK10 impact resistance rating (for the PC version) guarantees reliability in the harshest operating conditions. The IP69K tube achieves up to 194 lm/W, meeting the requirements of the highest energy class A. Through-beam versions, different lens distributions and two lengths (630 and 1220 mm) are available. In addition, versions with UGR<19, UGR<22, UGR<25 provide visual comfort even in demanding applications. Minimalist design, ease of installation and cleanliness make the Tuba IP69K a reliable and timeless solution.

APPLICATION

Ideal for areas requiring regular high-pressure cleaning, such as car washes, sewage treatment plants, food processing plants or slaughterhouses. It excels in environments with high humidity, sub-zero temperatures and aggressive fumes - from cold stores and freezers to mushroom, animal and plant farms. Thanks to its superior chemical and mechanical resistance, it is a reliable solution for workshops and service channels. It is also ideal for industrial halls, traffic routes and even as minimalist, decorative general lighting in commercial buildings.

TUBA IP69K GLASS 630MM 4300LM 840 LS2 (1F) VW IK06 26W

DETAILED CARD

TECHNICAL PARAMETERS TABLE

Index:	775116	Optics material:	PC
EAN:	5905963775116	Material of the body:	stainless steel
Light source:	LED module	Dimensions (H/W/T/S) [mm]:	697/64.5
Rated power of the luminaire [W]:	26	Mounting dimensions [mm]:	602.5
Luminous flux [lm]:	4300	Impact resistance:	IK06
Supply voltage [V]:	220-240	Ingress protection:	IP69K
Frequency [Hz]:	50-60	Mounting version:	surface, suspended
Luminous efficacy [lm/W]:	165	Working temperature [°C]:	from -30 to +35
Energy efficiency class:	B	Tilt angle adjustment [°]:	yes
Electrical protection class:	I	Wire type:	H07RN-F 3x1,5
Colour temperature [K]:	4000	Through wiring:	LS2
Color rendering index (Ra) >:	80	Remarks:	Cable length 2 x 1.4m
SDCM:	3	Accessories included:	surface-mounted bracket
LED lifespan L70B50 [h]:	137500	Number on the palette [pcs]:	154
LED lifespan L80B10 [h]:	86500	Net weight [kg]:	2.500
LED lifespan L90B10 [h]:	42000	Light distribution type:	VW
Beam angle [°]:	105	Warranty [years]:	5
Surge protection [kV]:	2	CE certificate:	11/2025
Diffuser material:	glass	Manual:	Download PDF
Diffuser colour:	transparent	Plik LDT:	Download
Optics:	matrix lens		

TUBA IP69K GLASS 630MM 4300LM 840 LS2 (1F) VW IK06 26W

DETAILED CARD
TECHNICAL PICTURES

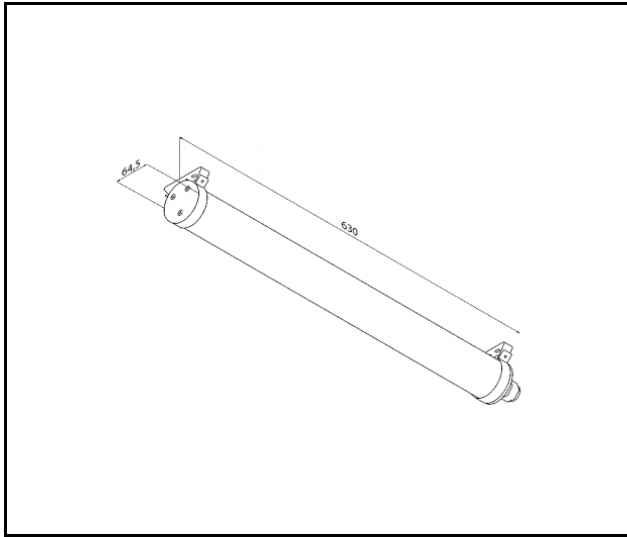

TUBA IP69K GLASS 630MM 4300LM 840 LS2 (1F) VW IK06 26W

DETAILED CARD

ACCESSORIES AVAILABLE

index	Name
778254	Tuba IP69K 3P connector set
778261	Connector set Tuba IP69K 5P DALI



Tuba IP69K 3P connector set (778254)



Connector set Tuba IP69K 5P DALI (778261)

Card creation date: 17 February 2025

The company reserves the right to make design changes or upgrades in the presented product. Product data sheet does not constitute an offer. * Parameter tolerance is +/- 10%



This product is a subject to electric and electronic waste equipment regulations (WEEE).



Certificate CE - Nr: 11/2025