

FACTOR LED 1M 33100 LM 840 ASN2 IP66 (234W)SH

DETAILED CARD



TECHNICAL PARAMETERS

Index:	994777
Ingress protection:	IP66
Impact resistance:	IK09
Rated power of the luminaire [W]*:	234
Luminous flux [lm]*:	33100
Colour temperature [K]:	4000
Color rendering index (Ra) >:	80
SDCM:	5
Electrical protection class:	I
Energy efficiency class:	C

CHARACTERISTICS

Factor Led is a latest-generation floodlight with a high power output and an impressive luminous flux. It is characterized not only by very high luminous efficiency but also by the highest IP 66 tightness and IK09 impact resistance. These parameters have been achieved thanks to the branded components used, robust housing made of cast aluminum, and the use of a passive cooling system for the lamp, which allows the excess heat generated to be dissipated during lamp operation. The Factor Led has the advantage of very fast and easy installation. The lightweight steel arm is attached to the supporting structure (wall, pole), and then the light modules are plugged in. On a single bracket, the installer can plug in a lamp containing from 1 to 4 such modules.

APPLICATION

Very good sealing and impact resistance parameters, the ability to work in elevated temperatures - up to 45 ° C as standard, and an extensive range of spreads predisposes Factor Led lamps to work in harsh weather conditions. It will find application and perform well both inside industrial halls, warehouses, sports halls, logistics centers, and outdoors - on sports fields, airports, parking lots, and maneuvering areas. It can also illuminate the facades of buildings and elements of external architecture.

FACTOR LED 1M 33100 LM 840 ASN2 IP66 (234W)SH

DETAILED CARD

TECHNICAL PARAMETERS TABLE

Index:	994777	Material of the body:	aluminium
Rated power of the luminaire [W]:	234	Colour of the body:	RAL7016
Luminous flux [lm]:	33100	Dimensions (H/W/T/S) [mm]:	191/425/217
Supply voltage [V]:	220-240	Impact resistance:	IK09
Frequency [Hz]:	47-63	Ingress protection:	IP66
Luminous efficacy [lm/W]:	141	Working temperature [°C]:	from -40 to +45
Energy efficiency class:	C	DIMM 1-10V:	yes
Electrical protection class:	I	Dimensions of single box [mm]:	430
Colour temperature [K]:	4000	Number on the palette [pcs]:	35
Color rendering index (Ra) >:	80	Net weight [kg]:	5,590
SDCM:	5	Version:	1 module
Power factor:	0.98	Warranty [years]:	5
LED lifespan L70B50 [h]:	156000	CE certificate:	262/2023
LED lifespan L80B10 [h]:	98000	ENEC Certificate:	0404/ENEC/25
LED lifespan L90B10 [h]:	47000	Environmental Product Declaration (EPD):	816/2025
Beam angle [°]:	ASN2	Manual:	Download PDF
Surge protection [kV]:	6	Plik LDT:	Download
Diffuser material:	tempered glass		

FACTOR LED 1M 33100 LM 840 ASN2 IP66 (234W)SH

DETAILED CARD

TECHNICAL PICTURES

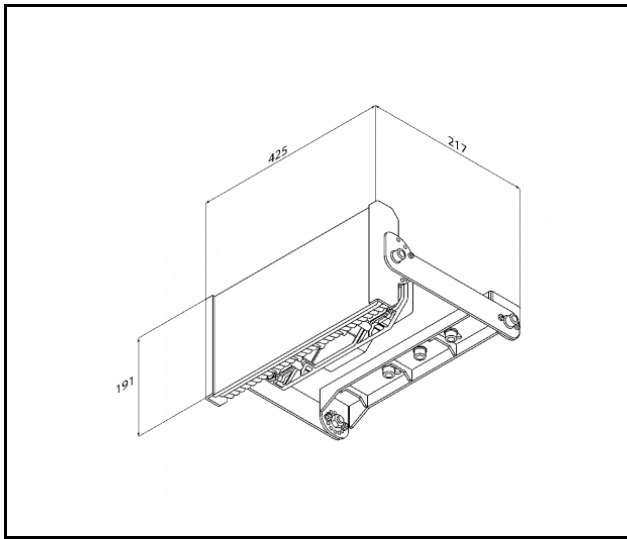

FACTOR LED 1M 33100 LM 840 ASN2 IP66 (234W)SH

DETAILED CARD

ACCESSORIES AVAILABLE

index	Name
684791	Protective grid Factor LED 4M RAL7016
684784	Protective grid Factor LED 3M RAL7016
684777	Protective grid Factor LED 2M RAL7016
684760	Protective grid Factor LED 1M RAL7016
370311	



Protective grid Factor LED 4M
RAL7016 (684791)



Protective grid Factor LED 3M
RAL7016 (684784)



Protective grid Factor LED 2M
RAL7016 (684777)

Card creation date: 21 January 2025

The company reserves the right to make design changes or upgrades in the presented product. Product data sheet does not constitute an offer. * Parameter tolerance is +/- 10%



This product is a subject to electric and electronic waste equipment regulations (WEEE).



Certificate CE - Nr: 262/2023