

# QUEST LED EVO XS 7300LM DALI I CL. IP67 740 ASN 52W

DETAILED CARD



## TECHNICAL PARAMETERS

<b>Index:</b>	865411
<b>Ingress protection:</b>	IP67
<b>Impact resistance:</b>	IK10
<b>Rated power of the luminaire [W]*:</b>	52
<b>Luminous flux [lm]*:</b>	7300
<b>Colour temperature [K]:</b>	4000
<b>Colour rendering index:</b>	>70
<b>SDCM:</b>	≤ 3
<b>Electrical protection class:</b>	I
<b>Energy efficiency class:</b>	C

## CHARACTERISTICS

Compact yet extremely powerful premium floodlight, manufactured in Poland. The body is made of die-cast aluminium in corrosivity class C5, powder-coated, with no external heat sink or fins to make maintenance difficult. A steel arm with a scale of 7.5 degrees is attached to the body. The diffuser is tempered glass, under which the highest performance LEDs are located. The different types of optics, particularly asymmetrical optics, provide a great deal of freedom in the selection for a specific solution. Thanks to the highest tightness on the floodlight market - IP67 and maximum impact resistance IK10, it will prove its worth in all conditions - regardless of the weather and place of installation. The new version of the well-established and proven QUEST model in its smallest version, offers even better luminous parameters, achieving an efficiency of over 170 lm/W. Quest LED Evo XS meets the requirements of the PN-EN 60598-2 part 5 standard, which allows them to be classified as illuminating projectors. This means full freedom of installation in any position, with 360° rotation and resistance to strong wind - an advantage not offered by other floodlights. An additional advantage for contractors is the sealed quick-release coupling - an innovative solution that eliminates traditional, time-consuming connection methods (with screws). Thanks to an intuitive colour-coded ratchet system, fitting the connector becomes simple, fast and tool-free. The accessory kit includes pole mounting brackets, a frame for flush mounting (e.g. sheds), light pollution reduction shades, and protective grids in two colours with different light reduction levels (white RAL7016: 4%, body colour RAL7016: 8%). The Quest LED Evo XS comes in a version with an integrated motion and twilight sensor (RCR on remote control) and in the ENDURA version (resistant to elevated ambient temperatures up to 50 degrees C), as well as in a version designed for RGB+W illumination and pendant - highbay.

## APPLICATION

Illumination of educational and administrative facilities, halls, garages, passageways, warehouses, shops, food industry and food-related retail and service facilities, building illumination, small sports fields, open spaces and car parks. Can be mounted as floodlight, on poles and masts, on building facades, as highbay (HB version), flush mounting (e.g. sheds).

# QUEST LED EVO XS 7300LM DALI I CL. IP67 740 ASN 52W

DETAILED CARD

## TECHNICAL PARAMETERS TABLE

Rated power of the luminaire [W]:	52	Remarks:	** Dimension taking into account the maximum deflection of the handle in each direction.
Index:	865411		
Colour temperature [K]:	4000	Mounting dimensions [mm]:	100
EAN:	5905963865411	Impact resistance:	IK10
Luminous flux [lm]:	7300	Ingress protection:	IP67
Light source:	LED	Mounting version:	surface
Supply voltage [V]:	220 - 240	Working temperature [°C]:	from -20 to +35
Frequency [Hz]:	50-60	DIMM DALI:	yes
Luminous efficacy [lm/W]:	140	Number on the palette [pcs]:	81
Energy efficiency class:	C	Net weight [kg]:	2.900
Electrical protection class:	I	Category type:	floodlights
Colour rendering index:	>70	Version:	floodlight
Light distribution type:	ASN	LED lifespan L70B50 [h]:	165 000
SDCM:	≤ 3	LED lifespan L80B20 [h]:	103 000
Surge protection [kV]:	6	LED lifespan L90B10 [h]:	50000
Diffuser material:	glass	Warranty [years]:	5
Diffuser type:	transparent	CE certificate:	<a href="#">02/2025</a>
Material of the body:	aluminium	Manual:	<a href="#">Download PDF</a>
Colour of the body:	RAL7016	Plik LDT:	<a href="#">Download</a>
Dimensions (H/W/T/S) [mm]:	280/240/55 (355/222/380)**		

## LIGHT CURVES

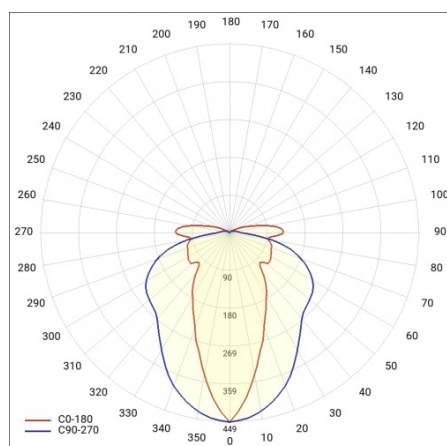

# QUEST LED EVO XS 7300LM DALI I CL. IP67 740 ASN 52W

DETAILED CARD

## ACCESSORIES AVAILABLE

index	Name
WSEL438	Remote control for motion sensor HD01R
840395	QUEST LED EVO XS pole holder
840425	QUEST LED EVO XS protective grid RAL7016
840456	QUEST LED EVO XS recessed frame RAL7016
840487	QUEST LED EVO XS cover RAL7016
881732	QUEST LED EVO XS protective grid RAL9003



Remote control for motion sensor  
HD01R (WSEL438)

Card creation date: 17 February 2025

The company reserves the right to make design changes or upgrades in the presented product. Product data sheet does not constitute an offer. \* Parameter tolerance is +/- 10%



This product is a subject to electric and electronic waste equipment regulations (WEEE).



Certificate CE - Nr: 02/2025